

## 60x60L Aluminium Profile (10mm Slot)

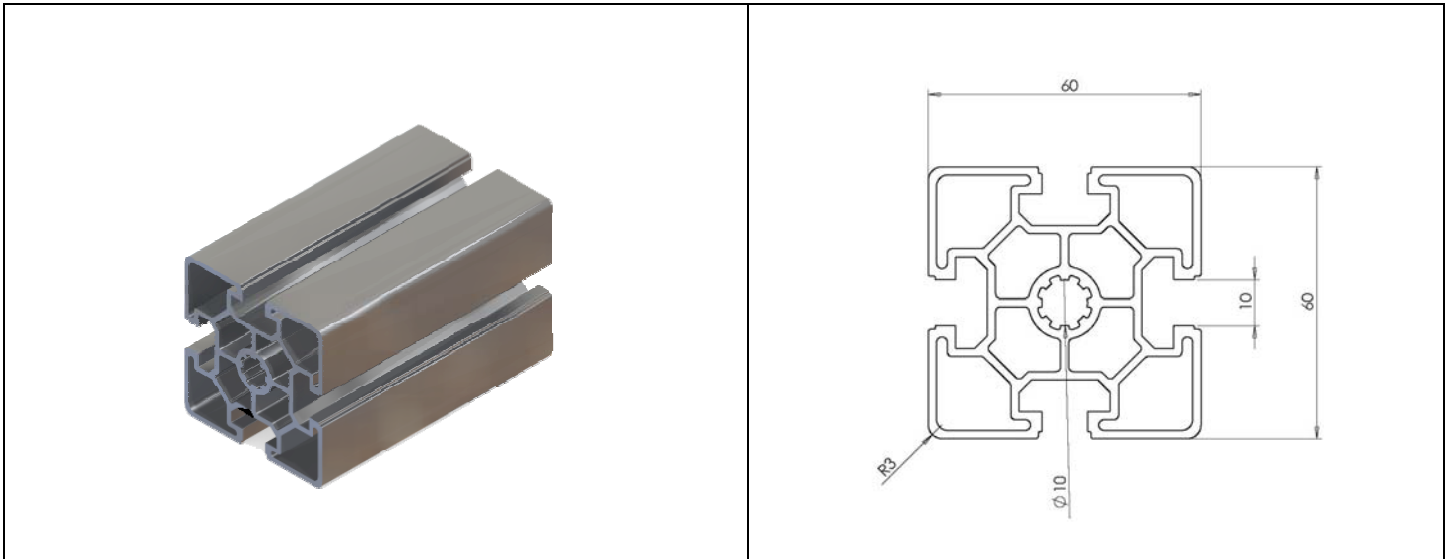

Max Length		6000mm
Part No		KJN 992 443
Profile		60x60 L
Slot Size		10mm
Mass		2.6kg/m
Moment of Inertia	Ix cm <sup>4</sup>	32.5
	Iy cm <sup>4</sup>	32.5
Section Modulus	Wx cm <sup>3</sup>	10.8
	Wy cm <sup>3</sup>	10.8
Profile Surface	A cm <sup>2</sup>	9.8